

● This hinge is flexible and can adapt to any shape of glass door, even the most extravagant designs.
Perfect for round showers !

- Made of brushed or polished stainless steel
- Self-closing function
- Interior and exterior opening
- For 10 mm glass and maximum 45 kg

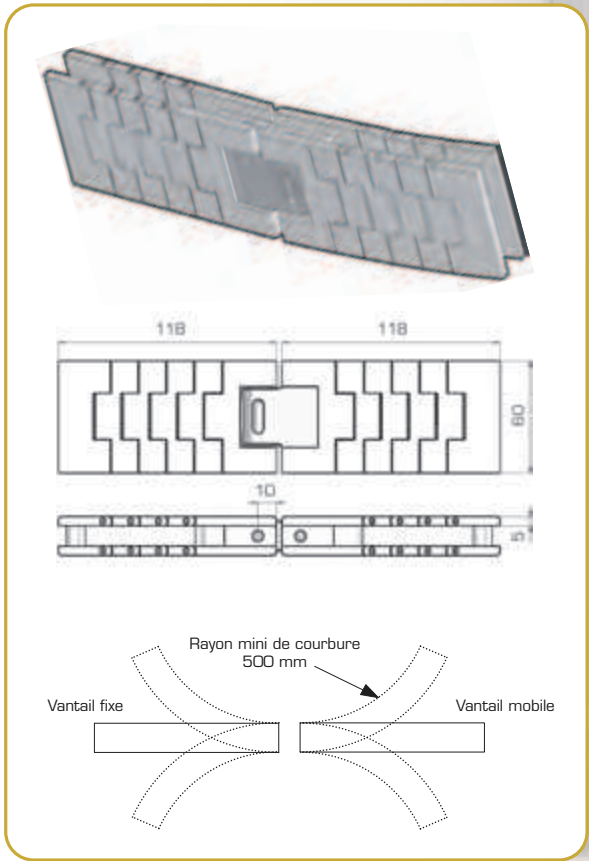

MODULIS

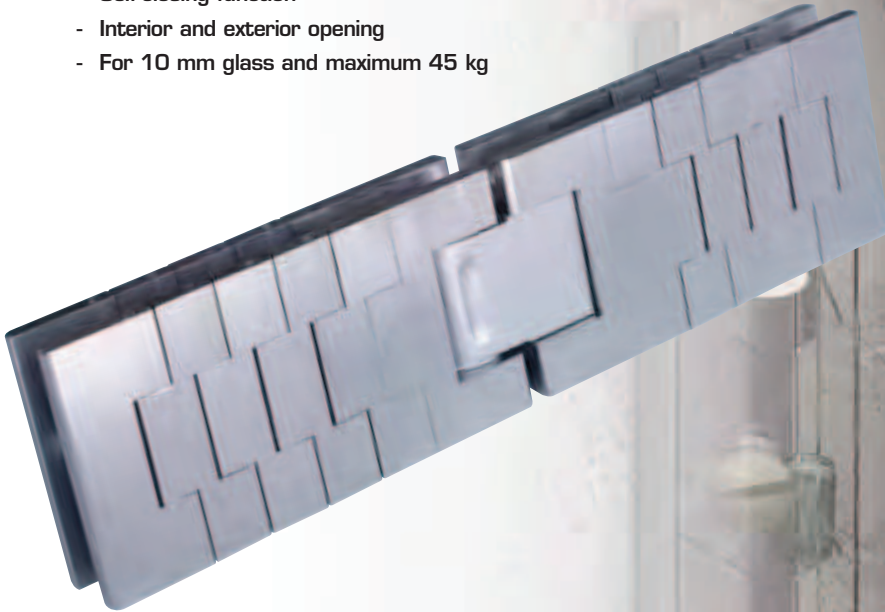

- - Double action hinge : in AND out opening
- Self-closing function of the door on the last 20 degrees
- A large choice of angles offers many original possibilities of construction : folding doors, enclosure for bath tube, overlapping glass doors etc...
- Ease of mounting : adjustment of the closed position ($\pm 5^\circ$) after the door has been installed
- Aesthetics and functionality : the wall plate can be delivered in a version with long holes (easy mounting) and cover (non visible wall screws).

STARDOUCH

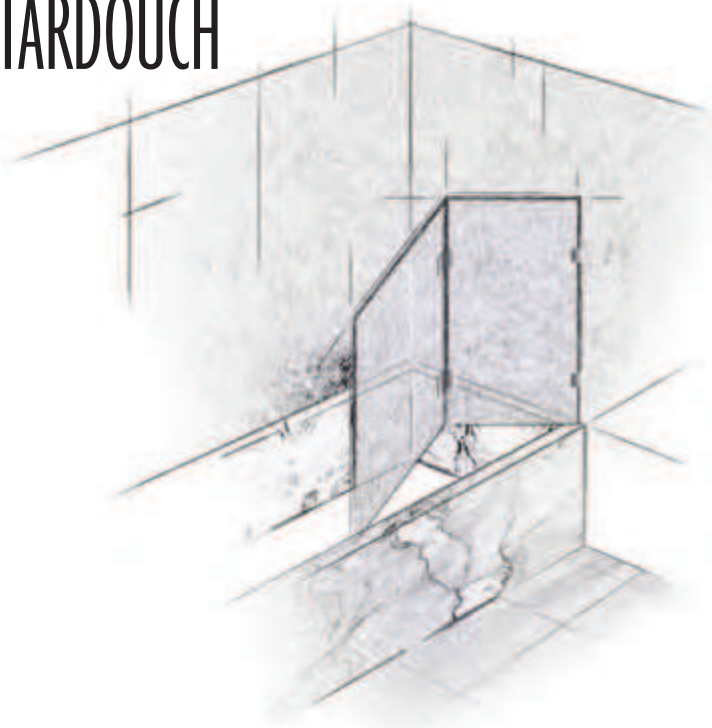

VISIOSTAR



● **Rewarded by Architects and Designers' Prizes**

Thin and flat Design : 1.5 mm salient on interior & exterior glass surface. Clearness & Transparency of the shower installation

Ease of cleaning : smooth glass surface and no visible screw to keep dirt

Security and solidity : patented fixing system, hinge tested and certified according to DIN-EN 14428 Norms

Ease of mounting : +/- 5° adjustment of the closed position

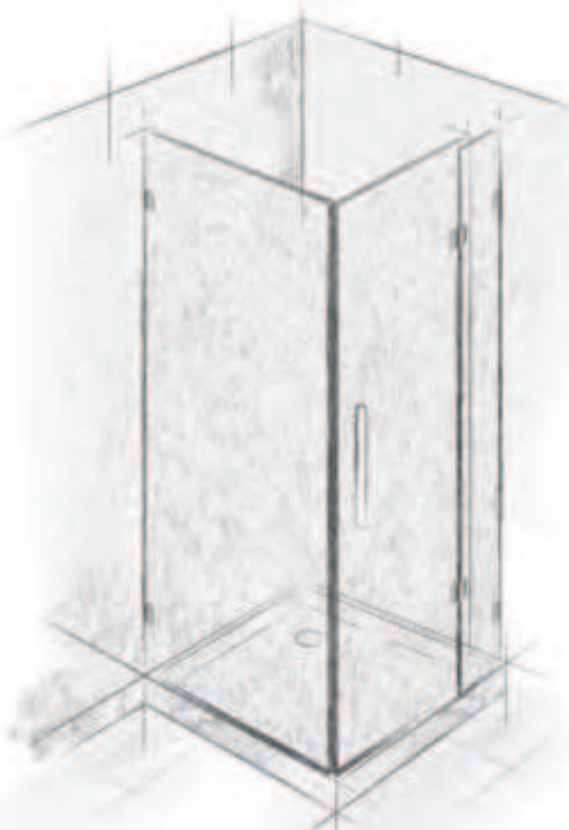
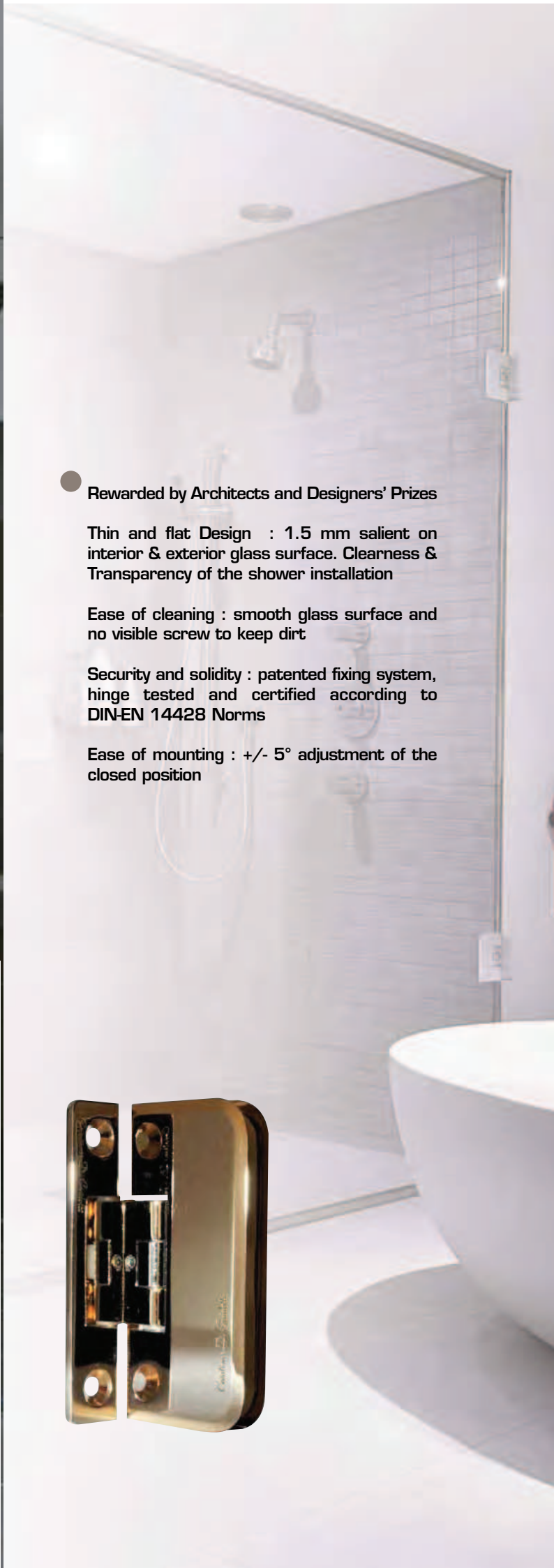

CS 621

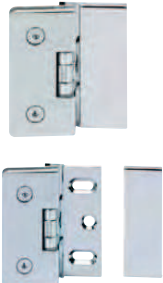

Wall mount

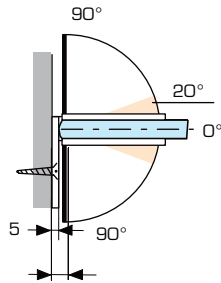

Glass/Wall 3 or 5 mm

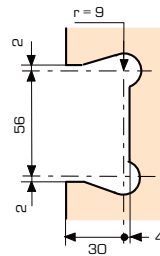

For 3 mm gap

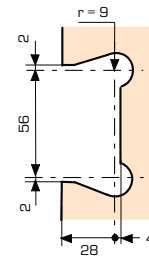

For 5 mm gap

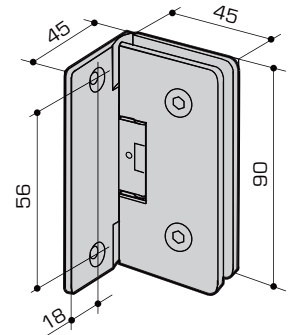

CS 66



Glass/Glass hinge overlapping

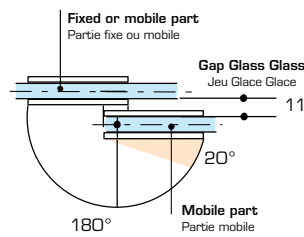

Overlapping of glass
(27mm = 13mm)

2 Holes/trous Ø 18

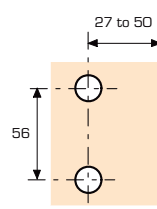

Fixed part

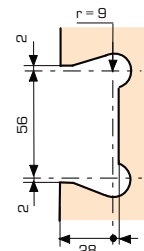

Mobile part

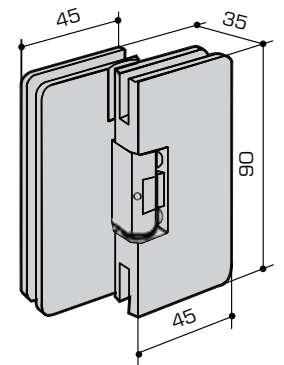

CS 61



Glass/Glass in extension

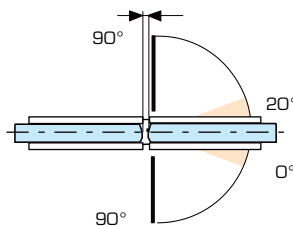

Glass/Glass 2 mm

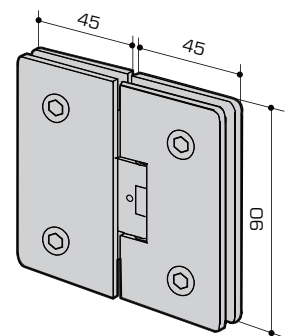
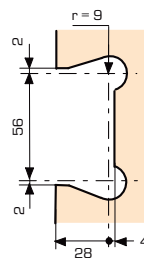

Automatic return area $\pm 20^\circ$

Glass

Thickness : 6.8.10 mm
Width : 800 mm max.
Weight : 35 kg max.

Hinge

Solid brass
Chrome thickness : 40 μ

Finishes

LC Bright Chrome
LP Polished Brass
LM Satin Chrome
NB Stainless Steel Look
DI Gold Plated
AB Antique Brass



CS 63



Glass to glass hinge bifold 360°

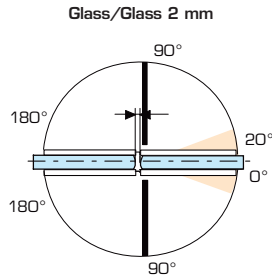

Maximum width of pane : 450 mm

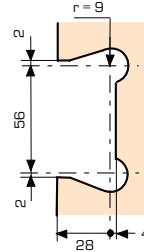

Maximum weight of pane : 15 kg

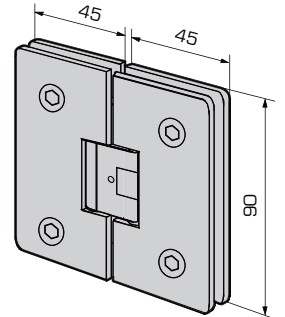

CS 505/ CS 062



Fitting for fixed pane wall mount 90°
Counterplate for Glass/Glas on CS620/CS507 and CS65

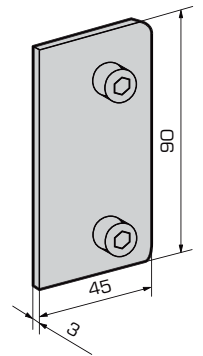
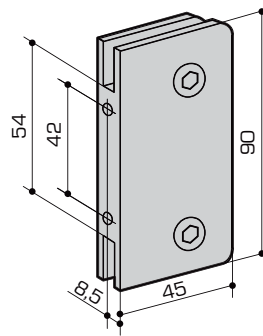
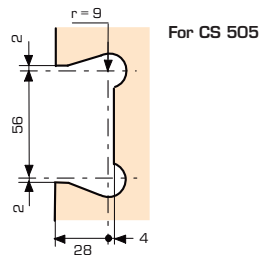

CS 517

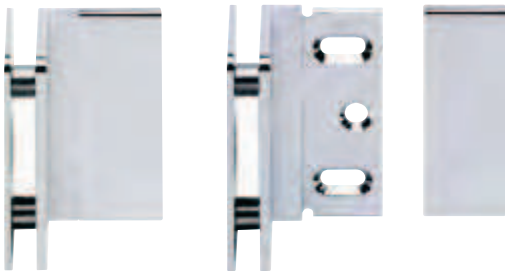

Fitting for fixed pane wall mount 90°

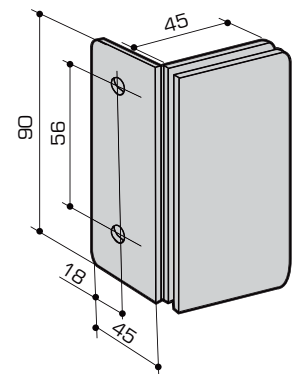
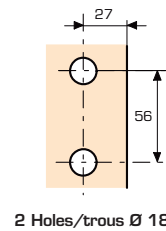
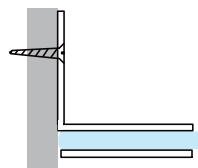

Automatic return area $\pm 20^\circ$

Glass

Thickness : 6.8.10 mm
Width : 800 mm max.
Weight : 35 kg max.

Hinge

Solid brass
Chrome thickness : 40 μ

Finishes

LC Bright Chrome
LP Polished Brass
LM Satin Chrome
NB Stainless Steel Look
DI Gold Plated
AB Antique Brass

CV2MH



Wall mount. wall plate with long holes and cover

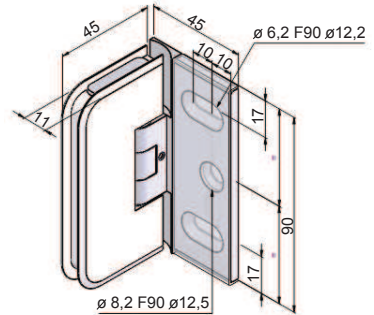
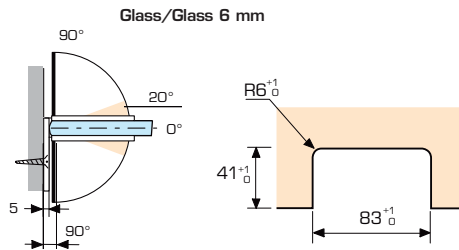

8 mm Glass : CV2MH

CV1M



Glass/Glass in extension

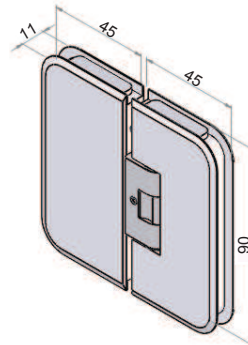
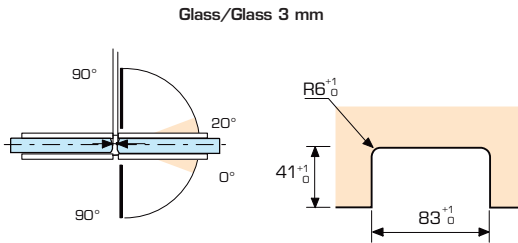

8 mm Glass : CV1M

CV7M



Fitting for fixed pane, wall mount 90°

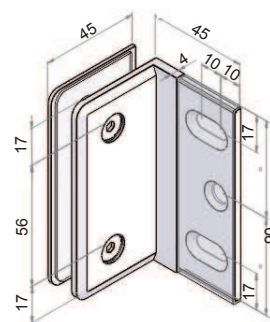
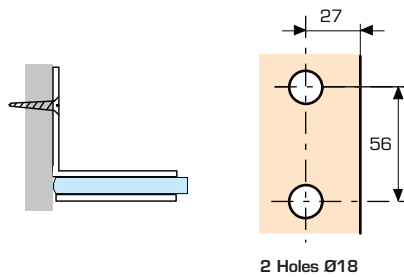

8 mm Glass : CV7M

Automatic return area $\pm 20^\circ$

Glass

Thickness : 8
 Width : 800 mm max.
 Weight : 35 kg max.

Hinge

Solid brass
 Chrome thickness : 40 μ

Finishes

LC Bright Chrome
 LP Polished Brass
 LM Satin Chrome
 NB Stainless Steel Look
 DI Gold Plated
 AB Antique Brass